



absoluteofficecomforts.com.au  
 26 Hutton Street, Osborne Park, WA 6017  
 E: info@aocoffice.com.au - 08 9201 1211

# CHATTER POD



## DESCRIPTION

The Chatter Pod is a revolutionary office furniture solution designed to provide individuals with personal privacy in a busy workspace, while also offering a sustainable alternative for conference, meeting, and collaboration spaces. The core concept revolves around utilizing environmentally friendly materials such as wood, PET acoustic panel and glass to significantly reduce carbon footprint and emissions compared to traditional metal or steel phone booths.



Table



Power Module

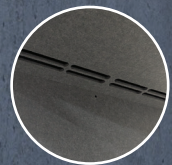

Ventilation

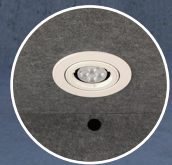

Light



Recycleable Materials



Eco-friendly Material



Sound Absorbing



Flame Retardant



Durable

## MATERIAL

- MDF board
- Glass
- Aluminum
- PET Acoustic Panel

## DIMENSION

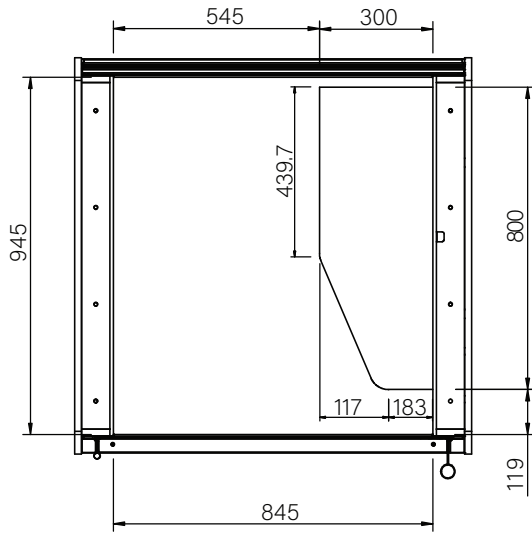

Top View

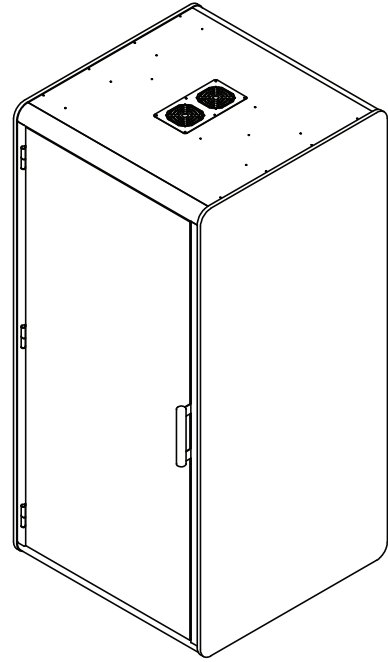

Isometric View

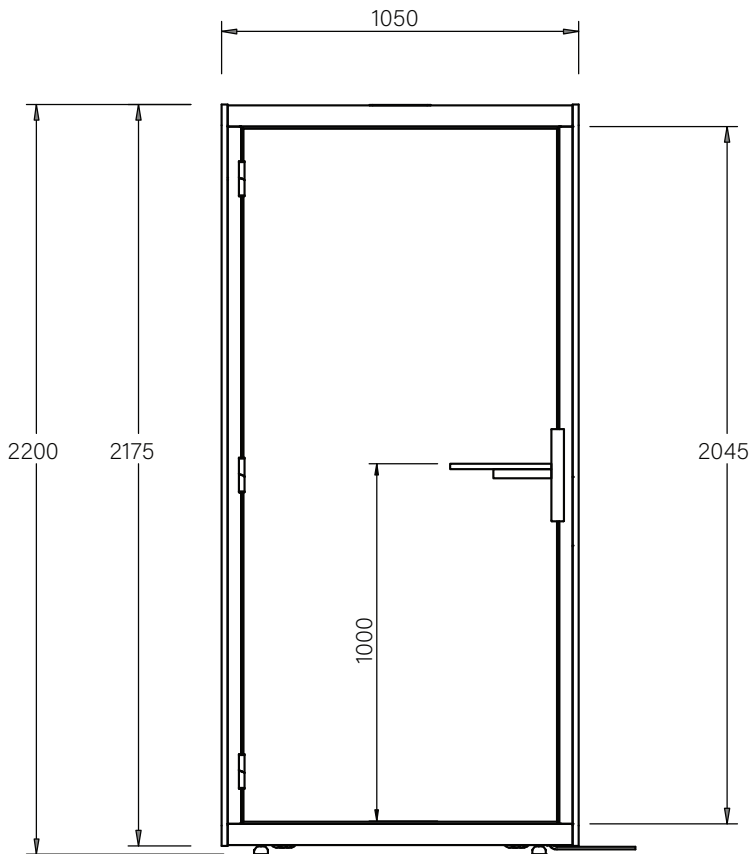

Front View

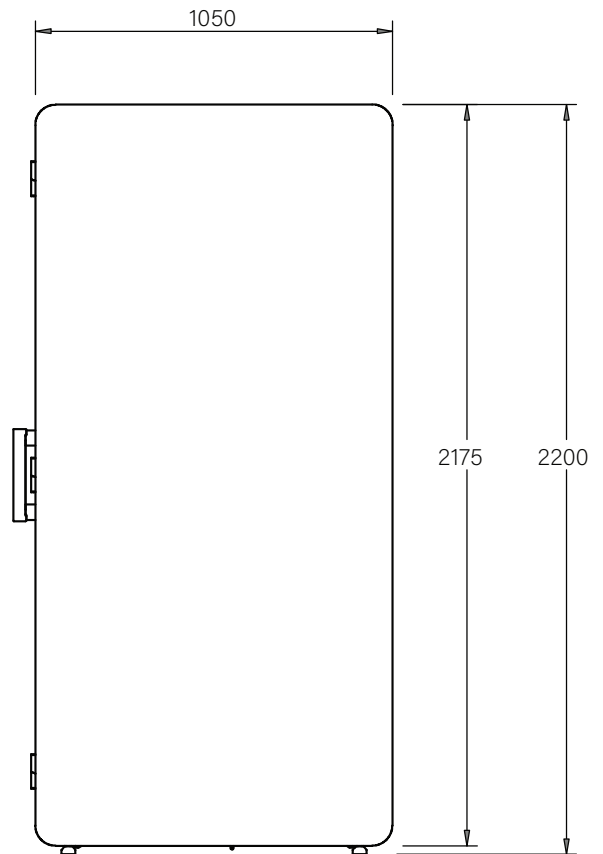

Back View



**PET Pattern Design**

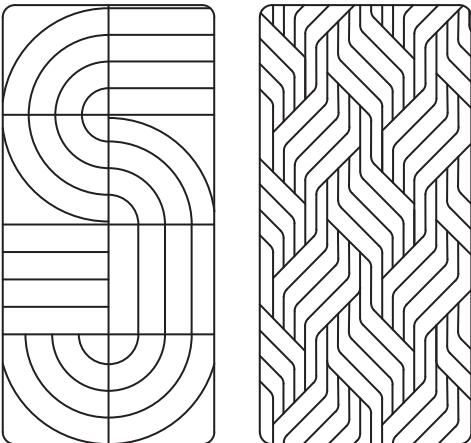

Custom designs available.  
Please check with us for details

**Optional Stool:**

- PP yellow shelf
- Base in Matt Black



**Made from recycled PET acoustic material**

PET OPTIONS

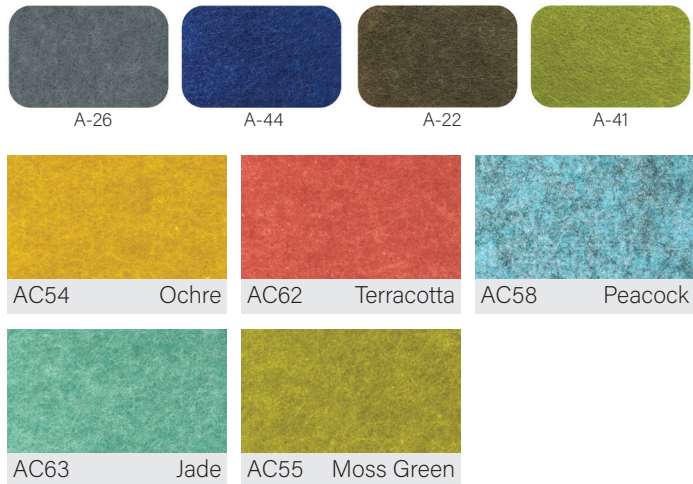

Our PET is certified:



